



# PNEUMATIC TOOLS



# 2020 CATALOG

# CONTENTS

- 3 EZ Grease Series Air Impact Wrenches
- 4 Air Impact Wrenches
- 13 Mini Air Tools
- 16 Air Ratchet Wrenches
- 18 Air Die Grinders
- 20 Air Angle Grinders
- 21 Air Cutting Tools
- 22 Air Drills
- 24 Air Screwdrivers
- 26 Air Needle Scalers
- 27 Air Hammers
- 28 Air Blow Guns
- 29 Air Auto Repair Tools
- 30 Socket Sets and Rails
- 33 Accessories
- 34 After Market Support



# **NEW** EZ GREASE SERIES AIR IMPACT WRENCHES

Introducing Mighty Seven's EZ Grease Series Impact Wrenches which are designed with an innovative "EZ" self-service maintenance method. The patented greasable anvil allows users to add grease, helping to prolong the tool's life, decrease loss of power and help shorten down-time. Each model within the EZ Grease series comes with pneumatic grease, an easy-to-use applicator and operating instructions.



## **NC-4233QHB**

**1/2" Drive Air Impact Wrench**  
**Twin Hammer Type**

Air inlet 1/4"

- Made from Heavy Duty Composite Material
- Max Torque 850FT-LB



## **NC-6255QHB**

**3/4" Drive Quiet Air Impact Wrench**  
**Twin Hammer Type**

Air inlet 1/4"

- Made from Composite Material
- Max Torque 1400FT-LB



## **NC-4650HB**

**1/2" Drive Air Impact Wrench**  
**Jumbo Hammer Type**

Air inlet 1/4"

- Made from Industrial strength Aluminum
- Max Torque 650FT-LB



## **NC-4255QHB**

**1/2" Drive Quiet Air Impact Wrench**  
**Twin Hammer Type**

Air inlet 1/4"

- Made from Composite Material
- Max Torque 1200FT-LB



**NEW!**

# AIR IMPACT WRENCHES



## NC-3612Q

**3/8" Drive Air Impact Wrench**  
**Jumbo Hammer Type**

Air inlet 1/4"

**MIGHTY QUIET**

- 350FT-lbs, 85dBA
- Weight: 3.9lbs, Width: 2.38"
- Height: 7.34", Length: 4.83"



## NC-4612Q

**1/2" Drive Air Impact Wrench**  
**Jumbo Hammer Type**

Air inlet 1/4"

**MIGHTY QUIET**

- 500FT-lbs, 85dBA
- Weight: 3.9lbs, Width: 2.38"
- Height: 7.34", Length: 4.83"

	Square Drive	Bolt Capacity	Torque Range	Max Torque		Free Speed	Avg. Air Consumption	Under Load	Air Pressure	Overall Length	Net Weight		Air Hose	Sound Pressure	Vibration Level
	Inch	Inch (mm)	FT-LB (Nm)	FT-LB	Nm	R.P.M	CFM (L/min)	CFM (L/min)	PSI (bar)	Inch (mm)	LBS	kg	Inch	dBA	m/s <sup>2</sup>
NC-3612Q	3/8"	1/2"(13)	100-300(136-407)	350	474	8000	4.0(113)	19.5(555)	90(6.3)	4-83/100"(123)	3.3	1.5	3/8"	85.0	2.8
NC-4612Q	1/2"	5/8"(16)	200-350(271-475)	500	678	9000	4.0(113)	21.1(595)	90(6.3)	4-83/100"(123)	3.3	1.6	3/8"	85.0	2.8
NC-4233QHB	1/2"	3/4"(19)	200-500(271-678)	850	1152	9000	4.6(132)	23.8	90(6.3)	7-1/2"(190)	4.6	2.10	3/8"	85.0	4.4
NC-4255QHB	1/2"	1"(25)	200-800(271-1085)	1200	1627	8500	4.8(136)	25.4	90(6.3)	7-1/32"(179)	3.7	1.7	3/8"	85.0	4.7
NC-4650HB	1/2"	5/8"(16)	180-400(244-542)	650	900	9000	4.69(132.8)	21.7(615)	90(6.3)	4-1/16"(104)	3.3	1.4	3/8"	95.0	2.4
NC-6255QHB	3/4"	1"(25)	200-1100(271-1491)	1400	1898	8500	4.8(136)	23.1	90(6.3)	7-13/16"(198)	4.2	1.9	3/8"	85.0	4.7

## NC-4232Q

**1/2" Drive Air Impact Wrench**  
**Twin Hammer Type**

Air inlet 1/4"

**MIGHTY QUIET**

○ 700 Ft-lbs, 83dBA

Weight: 3LBS, Width: 2-5/16"

Height: 7-5/16", Length: 4-3/4"



## NC-4630Q

**1/2" Drive Air Impact Wrench**  
**Jumbo Hammer Type**

Air inlet 1/4"

**MIGHTY QUIET**

○ 600 Ft-lbs, 85dBA

Weight: 3.3LBS, Width: 2-1/2"

Height: 7-3/8", Length: 3-7/8"



## NC-4620HQ

**1/2" Drive Air Impact Wrench**  
**Jumbo Hammer Type**

Air inlet 1/4"

**MIGHTY QUIET**

○ 500FT-lbs, 85dBA

○ 2" extended anvil with socket pin capacity.



## NC-4620QN3

**1/2" Drive Deep Thin Wall Impact Sockets**  
**Jumbo Hammer Type**

Air inlet 1/4"

**MIGHTY QUIET**

○ 3pcs. 1/2" Drive Flip Sockets 3/4" x 13/16" SAE  
17MM x 19MM, 21MM x 22MM

○ 2" extended anvil with socket pin capacity.



	Square Drive	Bolt Capacity	Torque Range	Max Torque	Free Speed	Avg. Air Consumption	Under Load	Air Pressure	Overall Length	Net Weight	Air Hose	Sound Pressure	Vibration Level
	Inch	Inch (mm)	FT-LB (Nm)	FT-LB Nm	R.P.M	CFM (L/min)	CFM (L/min)	PSI (bar)	Inch (mm)	LBS kg	Inch	dBA	m/s <sup>2</sup>
NC-4232Q	1/2"	5/8"(16)	100-400(136-542)	700 949	10000	4.0(113)	21.7(615)	90(6.3)	4-3/4" (120)	3.0 1.4	3/8"	83.0	3.7
NC-4620HQ	1/2"	5/8"(16)	200-350(271-475)	500 678	9000	4.4 (124)	21.7(615)	90(6.3)	6-9/16"(166)	3.74 1.7	3/8"	85.0	2.8
NC-4620QN3	1/2"	5/8"(16)	200-350(271-475)	500 678	9000	4.4 (124)	21.7(615)	90(6.3)	6-9/16"(166)	3.74 1.7	3/8"	85.0	2.8
NC-4630Q	1/2"	5/8"(16)	200-350(271-475)	600 813	9000	4.4(124)	21.7(615)	90(6.3)	3-27/32"(97)	3.3 1.50	3/8"	85.0	2.8



### NC-42330

1/2" Drive Air Impact Wrench

Twin Hammer Type

Air inlet 1/4"

- Made from Heavy Duty Composite Material
- Max Torque 850Ft-LB



### NC-42430

1/2" Drive Air Impact Wrench

Twin Hammer Type

Air inlet 1/4"

- Made from Heavy Duty Composite Material.
- Max Torque 850Ft-LB
- 2" Extended Anvil



### NC-4236Q

1/2" Drive Air Impact Wrench

Twin Hammer Type

Air inlet 1/4"

- Made from Industrial Grade Aluminum Material
- Max Torque 1000ft-lb



### NC-4246Q

1/2" Drive Air Impact Wrench

Twin Hammer Type

Air inlet 1/4"

- Made from Industrial Grade Aluminum Material
- Max Torque 1000ft-lb
- 2" Extended Anvil

	Square Drive	Bolt Capacity	Torque Range	Max Torque		Free Speed	Avg. Air Consumption	Under Load	Air Pressure	Overall Length	Net Weight		Air Hose	Sound Pressure	Vibration Level
	Inch	Inch (mm)	FT-LB (Nm)	FT-LB	Nm	R.P.M	CFM (L/min)	CFM (L/min)	PSI (bar)	Inch (mm)	LBS	kg	Inch	dBA	m/s <sup>2</sup>
NC-4233Q	1/2"	3/4"(19)	200-500(271-678)	850	1152	9000	4.6(132)	23.8	90(6.3)	7-1/2"(190)	4.6	2.10	3/8"	85.0	4.4
NC-4243Q	1/2"	3/4"(19)	200-500(271-678)	850	1152	9000	4.6(132)	23.8	90(6.3)	9-1/2" (241)	4.8	2.14	3/8"	85.0	4.4
NC-4236Q	1/2"	1(25)	200-700(271-949)	1000	1356	7500	5.5(155)	22.0	90(6.3)	6-45/64"(171)	5.7	2.48	3/8"	83.0	4.5
NC-4246Q	1/2"	1(25)	200-700(271-949)	1000	1356	7500	5.5(155)	22.0	90(6.3)	8-45/64" (223)	5.5	2.50	3/8"	83.0	4.5

## NC-4255Q

1/2" Drive Quiet Air Impact Wrench

Twin Hammer Type

Air inlet 1/4"

- Made from Composite Material
- Max Torque 1200Ft-LB



## NC-4265Q

1/2" Drive Quiet Air Impact Wrench

Twin Hammer Type

Air inlet 1/4"

- Made from Composite Material
- Max Torque 1200Ft-LB
- 2" Extended anvil



## NC-4256Q-2

1/2" Drive Quiet Air Impact Wrench

Twin Hammer Type

Air inlet 1/4"

- Made from Industrial Grade Aluminum Material
- Max Torque 1100Ft-LB
- 2" Extended anvil

## NC-4256Q

1/2" Drive Quiet Air Impact Wrench

Twin Hammer Type

Air inlet 1/4"

- Made from Industrial Grade Aluminum Material
- Max Torque 1100Ft-LB

	Square Drive	Bolt Capacity	Torque Range	Max Torque		Free Speed	Avg. Air Consumption	Under Load	Air Pressure	Overall Length	Net Weight		Air Hose	Sound Pressure	Vibration Level
	Inch	Inch (mm)	FT-LB (Nm)	FT-LB	Nm	R.P.M	CFM (L/min)	CFM (L/min)	PSI (bar)	Inch (mm)	LBS	kg	Inch	dBA	m/s <sup>2</sup>
NC-4255Q	1/2"	1"(25)	200-800(271-1085)	1200	1627	8500	4.8(136)	25.4	90(6.3)	7-1/32"(179)	3.7	1.7	3/8"	85.0	4.7
NC-4265Q	1/2"	1"(25)	200-800(271-1085)	1200	1627	8500	4.8(136)	25.4	90(6.3)	9-1/32"(230.5)	4.0	1.8	3/8"	85.0	4.7
NC-4256Q	1/2"	1"(25)	200-900(271-1220)	1100	1491	9000	5.1(144)	21.5	90(6.3)	5-9/16" (141)	4.0	1.8	3/8"	85.0	2.8
NC-4256Q-2	1/2"	1"(25)	200-900(271-1220)	1100	1491	9000	5.1(144)	21.5	90(6.3)	7-9/16" (191)	4.2	1.9	3/8"	85.0	2.8



**NC-6255Q**  
**3/4" Drive Quiet Air Impact Wrench**  
 Twin Hammer Type  
 Air inlet 1/4"  
 ○ Made from Composite Material  
 ○ Max Torque 1400FT-LB



**NC-6255Q-6**  
**3/4" Drive Quiet Air Impact Wrench**  
 Twin Hammer Type  
 Air inlet 1/4"  
 ○ Made from Composite Material  
 ○ Max Torque 1400FT-LB  
 ○ 6" extended anvil

	Square Drive	Bolt Capacity	Torque Range	Max Torque	Free Speed	Avg. Air Consumption	Under Load	Air Pressure	Overall Length	Net Weight	Air Hose	Sound Pressure	Vibration Level
	Inch	Inch (mm)	FT-LB (Nm)	FT-LB Nm	R.P.M	CFM (L/min)	CFM (L/min)	PSI (bar)	Inch (mm)	LBS kg	Inch	dBA	m/s <sup>2</sup>
NC-6255Q	3/4"	1"(25)	200-1100(271-1491)	1400 1898	8500	4.8(136)	23.1	90(6.3)	7-13/16"(198)	4.2 1.9	3/8"	85.0	4.7
NC-6255Q-6	3/4"	1"(25)	200-1100(271-1491)	1400 1898	8500	4.8(136)	23.1	90(6.3)	13-13/16"(350)	5.2 2.38	3/8"	85.0	4.7





## NC-6218

### 3/4" Drive Air Impact Wrench

#### Twin Hammer Type

Air inlet 1/2"

- Max Torque, 1500Ft-Lb.
- Only 12 9/16" (320MM) long. Compact size for D-Handle Type impact wrench
- Light weight (12.54lbs)



## NC-6236Q

### 3/4" Drive Air Impact Wrench

#### Twin Hammer Type

Air inlet 1/4"

- Max torque 1200FT-LB
- Low noise sound pressure 83dBA
- Handle exhaust efficiently reduces the noise and directs air away



## NC-6246Q

### 3/4" Drive Air Impact Wrench

#### Twin Hammer Type

Air inlet 1/4"

- Max Torque 1200FT-LB
- Low noise sound pressure 83dBA
- 6" extended anvil
- Light weight (7.0 lbs)

	Square Drive	Bolt Capacity	Torque Range	Max Torque		Free Speed	Avg. Air Consumption	Under Load	Air Pressure	Overall Length	Net Weight		Air Hose	Sound Pressure	Vibration Level
	Inch	Inch (mm)	FT-LB (Nm)	FT-LB	Nm	R.P.M	CFM (L/min)	CFM (L/min)	PSI (bar)	Inch (mm)	LBS	kg	Inch	dBA	m/s <sup>2</sup>
NC-6218	3/4"	1-1/16"(27)	200-1400(271-1898)	1500	2034	6000	6.34(182)	24.1(687)	90(6.3)	12-9/16"(320)	12.54	5.7	1/2"	106.0	3.3
NC-6236Q	3/4"	1"(25)	200-900(271-1220)	1200	1627	7500	5.5(155)	22.0(623)	90(6.3)	6-45/64"(171)	5.9	2.68	3/8"	83.0	4.5
NC-6246Q	3/4"	1"(25)	200-700(271-949)	1200	1627	7500	5.5(155)	22.0(623)	90(6.3)	12-45/64" (324)	7.0	3.18	3/8"	83.0	4.5

**NC-8219**

**1" Drive Air Impact Wrench  
New Twin Hammer Type**

Air inlet 1/2"

- Max Torque, 1800 Ft-lb
- Noise reduction silencer included



**NEW**

**NC-8266P**

**1" Drive Lightweight Air  
Impact Wrench**

**Twin Hammer Type**

Air inlet 1/2"

- Max Torque 2300Ft-LB
- Only 13lbs



**NC-8216  
NC-8226**

**1" Drive Air Impact Wrench  
Twin Hammer Type**

NC-8226 is equipped with 6" extended anvil

Air inlet 1/2"

- Max Torque, 1800 Ft-Lb
- Heavy duty composite body



**NC-8351**

**1" Drive Air Impact Wrench  
Pin Less Type**

NC-8351 is equipped with 8" extended anvil

Air inlet 1/2"

- Max Torque, 1800Ft-Lb
- Our #1 selling 1" Drive impact wrench

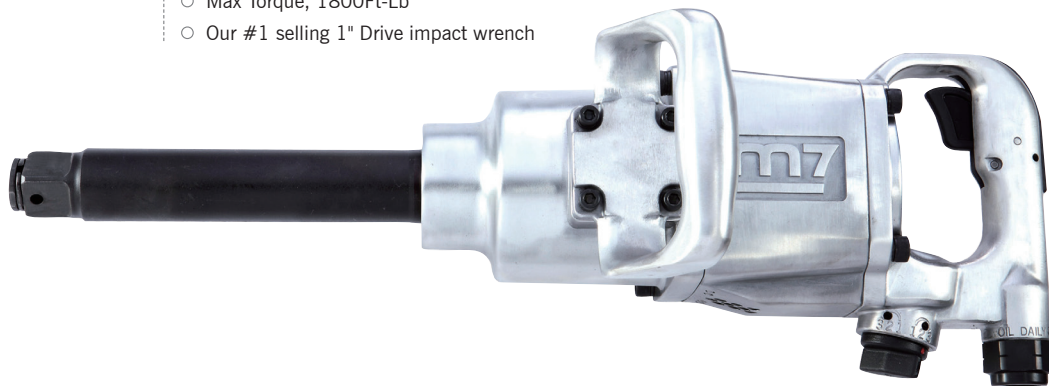

## NC-8343-8

### 1" Drive Air Impact Wrench Pin Less Type

Air inlet 1/2"

- Max Torque, 1800 Ft-Lb
- 3 power options in both directions



**NEW**



## NC-8332-6

### 1" Drive Air Impact Wrench Pin Less Type

6" extend anvil.

Air inlet 1/2"

- Max Torque 2500FT-LB

## NC-9223

### 1-1/2" Drive Air Impact Wrench New Twin Hammer Type

Air inlet 1/2"

- Max Torque, 3500 Ft-Lb
- Available with 8" extended anvil (NC-9243)



	Square Drive	Bolt Capacity	Torque Range	Max Torque	Free Speed	Avg. Air Consumption	Under Load	Air Pressure	Overall Length	Net Weight	Air Hose	Sound Pressure	Vibration Level
	Inch	Inch (mm)	FT-LB (Nm)	FT-LB Nm	R.P.M	CFM (L/min)	CFM (L/min)	PSI (bar)	Inch (mm)	LBS kg	Inch	dBA	m/s <sup>2</sup>
NC-8219	1"	1-7/16"(36)	200-1600(271-2170)	1800 2441	4000	11.0(311)	24.5(695)	90(6.3)	12-13/32"(315)	21.69 9.84	1/2"	103.4	16.7
NC-8216	1"	1-3/8"(33)	200-1600(271-2170)	1800 2441	6000	9.0(254)	23.7(670)	90(6.3)	13-1/2"(343)	15.58 7.0	1/2"	102.0	9.3
NC-8226	1"	1-3/8"(33)	200-1600(271-2170)	1800 2441	6000	9.0(254)	23.7(670)	90(6.3)	19-3/16"(487)	18.48 8.4	1/2"	102.0	9.3
NC-8266P	1"	1-3/8"(35)	200-2000(271-2710)	2300 3118	4500	9.0(254)	23.7(670)	90(6.3)	10"(256)	13 5.90	1/2"	92.0	6.1
NC-8332-6	1"	1-3/8"(35)	200-2000(271-2710)	2500 3390	4000	8.0(226.5)	25.0(708)	90(6.3)	20-11/16"(525)	23.3 10.6	3/8"	103	8.2
NC-8343-8	1"	1-3/8"(35)	200-1600(271-2170)	1800 2441	3900	11.5(325)	24.5(695)	90(6.3)	23"(590)	30.6 13.9	1/2"	103	6.3
NC-8351	1"	1-3/8"(33)	200-1600(271-2170)	1800 2441	4000	11.5(325)	24.5(695)	90(6.3)	20"(510)	27.6 12.5	1/2"	101.0	7.3
NC-9223	1-1/2"	2"(50)	200-3000(271-4065)	3500 4746	3000	16.0(453)	30.0(850)	90(6.3)	17-3/4"(450)	42.29 19.7	3/4"	104.5	8.8



## NC-2710

1/4" Drive air Impact Wrench  
Twin Dog Type

Air inlet 1/4"

- Great for working in tight spaces

## NC-0208M

1/4" Drive Air Impact Wrench  
Twin Dog Type

Air inlet 1/4"

- Glow Plug Removal Set  
1pc 1/4" Air Impact Wrench (NC-2710)
- 5pcs Socket:8.9.10.11.12mm
- 1pc 1/4" Drive Universal Joint
- 1pc 1/4" Extension Bar
- 1pc Plug (adapter)



NC-2710 has four torque settings when installing glow plugs.

Ranges from 7.4Ft-lb to 29.5Ft-lb.



Square Drive	Bolt Capacity	Torque Range	Max Torque	Free Speed	Avg. Air Consumption	Air Pressure	Overall Length	Net Weight	Air Hose	Sound Pressure	Vibration Level
Inch	Inch (mm)	FT-LB (Nm)	FT-LB Nm	R.P.M	CFM (L/min)	PSI (bar)	Inch (mm)	LBS kg	Inch	dBA	m/s <sup>2</sup>



NC- 2710	1/4"	1/2"(12)	7.4-29.5 (10-40)	29 40	11000	5.3(150)	90(6.3)	5-3/8" (136)	1.76 0.8	3/8"	91.0	3.4
----------	------	----------	------------------	-------	-------	----------	---------	--------------	----------	------	------	-----

# MINI AIR TOOLS

## NC-2210N [SET]

### 1/4" Drive Air Impact Wrench 10 pcs

Twin Dog Type Air inlet 1/4"

Contents:

- 1 pc D.R1/4" Impact Socket 8mm
- 1 pc D.R1/4" Impact Socket 9mm
- 1 pc D.R1/4" Impact Socket 10mm
- 1 pc D.R1/4" Impact Socket 11mm
- 1 pc D.R1/4" Impact Socket 12mm
- 1 pc D.R1/4" Extension Bar (L:50mm)
- 1 pc D.R1/4" Extension Bar (L:125mm)
- 1 pc D.R1/4" Universal Joint
- 1 pc 1/4" Plug
- 1 pc Air Impact Wrench



	Square Drive	Bolt Capacity	Torque Range	Max Torque	Free Speed	Avg. Air Consumption	Air Pressure	Overall Length	Net Weight	Air Hose	Sound Pressure	Vibration Level
	Inch	Inch (mm)	FT-LB (Nm)	FT-LB Nm	R.P.M	CFM (L/min)	PSI (bar)	Inch (mm)	LBS kg	Inch	dBA	m/s <sup>2</sup>
NC- 2210N	1/4"	MS	4-45(6-61)	50 67.8	11000	1.8(51)	90(6.3)	6-17/32"(166)	1.4 0.65	3/8"	77.0	1.8



## QA-651N [SET]

### Air Die Grinder 16 pcs

Air inlet 1/4"

Contents:

- 1 pc Air Die Grinder
- 1 pc Collet: 3mm (or 1/8")
- 5 pcs Grinder Stones 3mm
- 5 pcs Grinder Stones 6mm
- 1 pc 1/4" Plug
- 1 pc Oil Box
- 2 pcs Spanner Wrench

	Collet Size	Free Speed	Avg. Air Consumption	Air Pressure	Overall Length	Hose Length	Net Weight	Air Hose	Sound Pressure	Vibration Level
	Inch(mm)	R.P.M	CFM (L/min)	PSI (bar)	Inch (mm)	mm	LBS(kg)	Inch	dBA	m/s <sup>2</sup>
QA- 651N	1/4" (6)	18000	2.7(76)	90(6.3)	5"(127)	---	1.10 0.5	3/8"	74.0	0.3



### QP-212N [SET]

**Air High Speed Sander 12 pcs**

Air inlet 1/4"

Contents:

- 1 pc Air High Speed Sander
- 1 pc 2" Rubber PAD (1/4" - 20)
- 1 pc 2" Pad Die #80
- 1 pc 2" Stripping Disc #80-YL(Coarse)
- 1 pc 2" Stripping Disc #150-RD(Med)
- 1 pc 3" Rubber PAD (1/4"-20)
- 1 pc 3" Pad Die #80
- 1 pc 3" Stripping Disc #80-YL(Coarse)
- 1 pc 3" Stripping Disc #150-RD(Med)
- 1 pc 1/4" Plug
- 1 pc Oil Box
- 1 pc Spanner Wrench



### QP-213N [SET]

**Air Mini Sander 67 pcs**

Air inlet 1/4"

Contents:

- 1 pc Air Mini Sander
- 1 pc 2" PAD (5/16" - 24)
- 1 pc 3" PAD (5/16" - 24)
- 10 pcs 2" Sandpaper #180
- 10 pcs 2" Sandpaper #220
- 10 pcs 2" Sandpaper #320
- 10 pcs 3" Sandpaper #180
- 10 pcs 3" Sandpaper #220
- 10 pcs 3" Sandpaper #320
- 1 pc 1/4" Plug
- 1 pc Oil Box
- 2 pcs Spanner Wrench



### QP-223N [SET]

**Air Mini Polisher 7 pcs**

Air inlet 1/4"

Contents:

- 1 pc Air Mini Polisher
- 1 pc 3" PAD
- 1 pc 3" Sponge (Medium)
- 1 pc 3" Sponge (Rough)
- 1 pc 3" Woolb Bonnet
- 1 pc 1/4" Plug
- 1 pc Spanner Wrench

	Pad Dia	Free Speed	Avg. Air Consumption	Air Pressure	Overall Length	Motor	Net Weight	Air Hose	Sound Pressure	Vibration Level	Spindle Size
	inch(mm)	R.P.M	CFM (L/min)	PSI (bar)	Inch (mm)	HP	LBS kg	Inch	dBA	m/s <sup>2</sup>	
QP- 212N	2" and 3"	18000	2.1(59)	90(6.3)	4-1/4"(107)	0.38	1.1 0.50	3/8"	73.0	0.9	1.4"-20
QP- 213N	2" and 3"	18000	2.1(59)	90(6.3)	4-5/8"(117)	0.38	1.1 0.50	3/8"	76.0	1.2	5/16"-24
QP- 223N	3"(76)	5500	2.2(62)	90(6.3)	5-1/8"(130)	0.38	1.3 0.50	3/8"	74.0	0.9	5/16"-24N

## QE-323N [SET]

### Air Reversible Drill 9 pcs

Air inlet 1/4"

Contents:

- 1 pc 3.5mm Drill Bits
- 1 pc 4.0mm Drill Bits
- 1 pc 4.5mm Drill Bits
- 1 pc 5.0mm Drill Bits
- 1 pc 5.5mm Drill Bits
- 1 pc Key Wrench
- 1 pc 1/4" Plug
- 1 pc Oil Box
- 1 pc Air Reversible Drill



	Chuck Size	Free Speed	Motor	Avg. Air Consumption	Air Pressure	Overall Length	Net Weight		Air Hose	Sound Pressure	Vibration Level
	inch(mm)	R.P.M	hp	CFM (L/min)	PSI (bar)	Inch (mm)	LBS	kg	Inch	dBA	m/s <sup>2</sup>
QE-323N	1/4"(6.35)	1600	0.38	1.9(113)	90(6.3)	6-15/32"(164)	2.5	0.78	3/8"	74.0	1.2



## RA-505N [SET]

### Air Screwdriver 16 pcs

Twin Dog Type Air inlet 1/4"

Contents:

- 1 pc Air Angle Die Grinder
- 2 pcs Bits FD(L:50mm)
- 2 pcs Bits PH2(L:65mm)
- 1 pc Bits PH2(L:100mm)
- 1 pc 1/4" Plug
- 1 pc Oil Box

	Chuck Size	Torque Range	Free Speed	Avg. Air Consumption	Air Pressure	Overall Length	Net Weight		Air Hose	Sound Pressure	Vibration Level
	inch(mm)	FT-LB(Nm)	R.P.M	CFM (L/min)	PSI (bar)	Inch (mm)	LBS	kg	Inch	dBA	m/s <sup>2</sup>
RA-505N	1/4"(6.35)	5-45(6-61)	11000	1.8(51)	90(6.3)	6-5/16"(161)	1.54	0.7	3/8"	74.0	3.3

# AIR RATCHET WRENCHES

## NE-251 NE-351

1/4" Drive & 3/8" Drive Stubby  
Air Ratchet Wrench

Air inlet 1/4"



## NE-462

1/2" Drive Air Ratchet Wrench  
Pin Clutch Type

Air inlet 1/4"



## NE-321 NE-421

3/8" Drive & 1/2" Drive Air Ratchet Wrench

Air inlet 1/4"



## NE-343 NE-443

3/8" Drive & 1/2" Drive Air Ratchet Wrench

Air inlet 1/4"



## NE-352

3/8" Drive Stubby  
Air Ratchet Wrench

Air inlet 1/4"

- 3/8" Drive anvil with 1/4" bit capacity

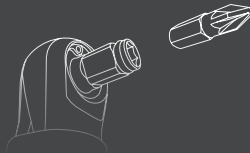

## NE-0357 (SET)

3/8" Drive Air Ratchet Wrench 57pcs

Air inlet 1/4"

- 1pc Air Ratchet Wrench (NE-352)
- 7pcs 1/4" Dr. socket : 4,5,6,7,8,9,10 mm
- 6pcs 3/8" Dr. socket : 11,12,13,14,15,17 mm
- 40pcs 1/4" Bits
- 1pc 3/8" Extension Bar
- 1pc 1/4" Hex Size shank driver
- 1pc Plug (Adapter)



	Square Drive	Torque Range	Max Torque		Free Speed	Avg. Air Consumption	Air Pressure	Overall Length	Net Weight		Air Hose	Sound Pressure	Vibration Level
	Inch	FT-LB (Nm)	FT-LB	Nm	R.P.M	CFM (L/min)	PSI (bar)	Inch (mm)	LBS	kg	Inch	dBA	m/s <sup>2</sup>
NE-251	1/4"	5-15(6.7-20)	22	30	350	3.0(84.96)	90(6.3)	5"(125)	1.1	0.5	3/8"	89.0	4.4
NE-351	3/8"	5-15(6.7-20)	22	30	350	3.0(84.96)	90(6.3)	5"(125)	1.1	0.5	3/8"	89.0	4.4
NE-321	3/8"	10-35(13.5-47)	50	68	160	4.0(113.28)	90(6.3)	10-3/8"(265)	2.3	1.04	3/8"	91.0	3.9
NE-421	1/2"	10-35(13.5-47)	50	68	160	4.0(113.28)	90(6.3)	10-3/8"(265)	2.3	1.04	3/8"	92.8	4.6
NE-352	3/8"	5-15(6.7-20)	22	30	350	3.0(84.96)	90(6.3)	5"(125)	1.1	0.5	3/8"	89.0	4.4
NE-343	3/8"	10-55(13.5-74)	75	101.7	160	4.0(113)	90(6.3)	11"(280)	2.8	1.3	3/8"	84.0	4.4
NE-443	1/2"	10-55(13.5-74)	100	135.6	160	4.0(113)	90(6.3)	11"(280)	2.8	1.3	3/8"	84.0	4.4
NE-462	1/2"	10-55(13.5-74)	74	100	200	4.0(113.28)	90(6.3)	13"(330)	4.10	1.88	3/8"	84.0	2.5
NE-461	1/2"	10-65(13.5-88)	100	135.6	180	4.0(113.28)	90(6.3)	10-3/8"(270)	2.64	1.20	3/8"	83.0	2.3



## NE-362

### 3/8" Drive Air Ratchet Wrench

Air inlet 1/4"

- Rear exhaust design so air is directed away from work area
- Overall length is only 6-3/8" Ideal for tight access applications



3/8" Drive anvil includes a 1/4" hex bit holder



## NE-399 NE-499

### 3/8" & 1/2" Drive Air Impact Ratchet

Air inlet 1/4"

- Max torque:  
NE-499 250FT-LB  
NE-399 180FT-LB
- Easy Forward & Reverse ring control on body.
- Ideal for tight access applications



## NE-483

### 1/2" Drive Air Ratchet Wrench

Air inlet 1/4"

- Innovative dual stage power
- Max reverse torque: 100FT-LB
- 85 dBA noise level exceeds OSHA standards
- Low vibration levels of 2.0

## NE-0413M(SET) NE-0413S(SET)

### 1/2" Drive (Thru-Hole Type) Air Ratchet Wrench 13pcs

Air inlet 1/4"

- 1pc Air Ratchet Wrench (NE-461)
- 8pcs 3/4" Hex Thru-hole socket : 8,9,10,12,13,14,17,19 mm (NE-0413M)
- 8pcs 3/4" Hex Thru-hole socket : 5/16",3/8",7/16",1/2",9/16",5/8",11/16",3/4" (NE-0413S)
- 1pc 3" Extension Bar
- 2pcs 1/2" 3/8" ADP
- 1pc Plug (Adapter)



Thru- hole socket set is available on page.....

	Square Drive	Bolt Capacity	Torque Range	Max Torque		Free Speed	Avg. Air Consumption	Under Load	Air Pressure	Overall Length	Net Weight		Air Hose	Sound Pressure	Vibration Level
	Inch	Inch (mm)	FT-LB (Nm)	FT-LB	Nm	R.P.M	CFM (L/min)	CFM (L/min)	PSI (bar)	Inch (mm)	LBS	kg	Inch	dBA	m/s <sup>2</sup>
NE-362	3/8"	N/A	10-35(13.5-47)	37	50	230	4.6(130)	N/A	90(6.3)	6-5/16"(160)	1.1	0.50	3/8"	88.0	3.0
NE-399	3/8"	1/2"(13)	50-130(68-176)	180	244	7500	2.45(69.4)	24.1	90(6.3)	13-3/8"(340)	4.0	18.3	3/8"	93.0	9.9
NE-499	1/2"	9/16"(14)	50-150(68-203)	250	339	7500	2.45(69.4)	24.1	90(6.3)	13-3/8"(340)	4.0	18.3	3/8"	93.0	9.9
NE-483	1/2"	N/A	10-65(13.5-61)	100	81	250	5.0(141)	N/A	90(6.3)	10-29/32"(277)	2.82	1.28	3/8"	85.0	2.0

# AIR DIE GRINDERS

**QA-111B**  
(Inch Size)  
**Air Die Grinder**  
Air inlet 1/4"



**QA-313B**  
(Inch Size)  
**Air Die Grinder**  
Air inlet 1/4"



**QA-315B**  
(Inch Size)  
**Air Die Grinder**  
Air inlet 1/4"



**QA-110B**  
(Inch Size)  
**Air Die Grinder**  
Air inlet 1/4"



**QA-116B**  
(Inch Size)  
**Air Die Grinder**  
Air inlet 1/4"



**QA-211B**  
(Inch Size)  
**Air Die Grinder**  
Air inlet 1/4"



**QA-311B**  
(Inch Size)  
**Air Die Grinder**  
Air inlet 1/4"



	Collet Size A mm	Collet Size B inch	Free Speed R.P.M	Avg. Air Consumption CFM (L/min)	Air Pressure PSI (bar)	Overall Length Inch (mm)	Motor HP	Net Weight LBS(kg)	Air Hose Inch	Sound Pressure dBA	Vibration Level m/s <sup>2</sup>	
QA-111B	6 & 3	1/4" & 1/8"	25000	10.0(283)	90(6.3)	6"(155)	0.3	0.84	0.38	3/8"	81.5	1.8
QA-311B	6 & 3	1/4" & 1/8"	25000	10.0(283)	90(6.3)	7-1/2"(190)	0.3	1.06	0.48	3/8"	81.5	1.8
QA-313B	6 & 3	1/4" & 1/8"	25000	10.0(283)	90(6.3)	9-1/4"(235)	0.3	1.28	0.58	3/8"	81.5	1.8
QA-315B	6 & 3	1/4" & 1/8"	25000	10.0(283)	90(6.3)	11"(280)	0.3	1.39	0.63	3/8"	81.5	1.8
QA-211B	6 & 3	1/4" & 1/8"	20000	10.0(283)	90(6.3)	7-1/2"(190)	0.9	1.43	0.65	3/8"	75.7	0.8
QA-110B	6 & 3	1/4" & 1/8"	22000	5.0(141)	90(6.3)	7-5/16"(186)	0.5	1.36	0.62	3/8"	85.0	1.1
QA-116B	6 & 3	1/4" & 1/8"	22000	5.0(141)	90(6.3)	13-9/16"(345)	0.5	2.53	1.15	3/8"	85.0	1.8

**NEW**

**QA-101B**

(Inch Size)

**Air Die Grinder**

Air inlet 1/4"



**NEW**

**QA-601B**

(Inch Size)

**90° Air Angle Die Grinder**

Air inlet 1/4"



**QA-611B**

(Inch Size)

**90° Air Angle Die Grinder**

Air inlet 1/4"

**QA-633QB**

(Inch Size)

**97° Air Angle Die Grinder**

Air inlet 1/4"



Direct drive inner mechanism to increase a longer lifespan.



**QA-681B**

(Inch Size)

**90° Air Angle Die Grinder**

Air inlet 1/4"

	Collet Size A mm	Collet Size B inch	Free Speed R.P.M	Avg. Air Consumption CFM (L/min)	Air Pressure PSI (bar)	Overall Length Inch (mm)	Motor HP	Net Weight LBS(kg)	Air Hose Inch	Sound Pressure dBA	Vibration Level m/s <sup>2</sup>
QA-101B	6	1/4"	25000	6.3(141)	90(6.3)	4-11/16"(119)	0.3	0.71 0.32	3/8"	80.0	1.4
QA-6011B	6 & 3	1/4" & 1/8"	22000	10.0(283)	90(6.3)	4-3/4"(120)	0.3	0.97 0.44	3/8"	84.0	1.1
QA-601B	6 & 3	1/4" & 1/8"	19000	10.0(283)	90(6.3)	6-1/8"(160)	0.3	1.12 0.51	3/8"	74.4	1.7
QA-633QB	6 & 3	1/4" & 1/8"	15000	17.2(490)	90(6.3)	7-1/8"(180)	0.6	1.54 0.70	3/8"	75.0	>2.5
QA-681B	6 & 3	1/4" & 1/8"	20000	5CFM(141.6)	90(6.3)	7-11/16(195)	0.5	1.6 0.80	3/8"	85.0	1.1

# AIR ANGLE GRINDERS

## QB-177

### Air Angle Grinder / Lever Type Throttle

Note : The grinding wheel is not supplied along with the tool

Air inlet 3/8"



## QB-7114SH

## QB-7145SH

## QB-7115SH

### Air Angle Grinder / Lever Type Throttle

Note : The grinding wheel is not supplied along with the tool

Air inlet 1/4"

- 1.3 HP Motor For stall resistance. One piece housing reduces maintenance costs.
- Heavy duty air cooled spiral gears and double bearings for durability.

○ **New feature** Wheel cover rotates 100 degrees



## QB-179

### Air Angle Grinder / Lever Type Throttle

Note : The grinding wheel is not supplied along with the tool

Air inlet 3/8"

## QB-197Q

### Air Angle Grinder / Lever Type Throttle

Note : The grinding wheel is not supplied along with the tool

Air inlet 1/4"

- 77dBA meets OSHA safety standards



	Pad Dia	Spindle Size	Free Speed	Avg. Air Consumption	Air Pressure	Overall Length	Motor	Net Weight	Air Hose	Sound Pressure	Vibration Level	
	Inch(mm)		R.P.M	CFM (L/min)	PSI (bar)	Inch (mm)	HP	LBS(kg)	Inch	dBA	m/s <sup>2</sup>	
QB-177	7"(178)	5/8"-11	7600	6.0(170)	90(6.3)	11-13/16"(170)	1.0	7.26	3.3	3/8"	92.0	2.7
QB-179	9"(230)	5/8"-11	6000	7.0(198)	90(6.3)	11"(279)	3.8	13.2	6.0	3/4"	86.0	2.1
QB-7114SH	4"(100)	3/8"-24 / M10*P1.5	11000	4.2(119)	90(6.3)	9-1/8"(232)	1.30	4.0	1.81	3/8"	90.0	1.2
QB-7145SH	4-1/2" (114)	5/8"-11 / M14*P2.0	11000	4.2(119)	90(6.3)	8-7/8"(232)	1.30	4.0	1.81	3/8"	90.0	1.2
QB-7115SH	5" (125)	5/8"-11 / M14*P2.0	11000	4.2(119)	90(6.3)	9-1/8"(232)	1.30	4.0	1.81	3/8"	90.0	1.2
QB-197Q	7"(178)	5/8"-11	7000	6.0(170)	90(6.3)	13-15/16"(353)	1.0	6.8	3.10	3/8"	77.0	1.5

# AIR CUTTING TOOLS



## QC-234

### 4" Air Corner Cut-Off Tool

Air inlet 1/4"

Available Dimension of inner hold : Ø 10mm Ø 16mm

## QC-213

### Heavy Duty Air Cut-Off Tool (Wheel Size 3")

Air inlet 1/4"

Note: wheel is supplied with the tool

Spindle : Ø 10mm



## QG-103

### Air Nibbler

Air inlet 1/4"



## QB-49602

### 6" Heavy Duty Dual Action Sander

- Lock off throttle to prevent accidental start up
- Rotary or random orbital options
- 20,000 RPM at free speed
- Air inlet 1/4"

## QD-321

### Low Vibration Air Body Saw

- Low sound pressure 83dBA
- Air flow designed to reduce vibration level by 30%
- 11,000 strokes per minute
- Air inlet 1/4"



## QG-202

### Air Shear / Pistol Type

Air inlet 1/4"

	Belt Size Pad Dia <small>inch(mm)</small>	Free Speed <small>R.P.M</small>	Avg. Air Consumption <small>CFM (L/min)</small>	Air Pressure <small>PSI (bar)</small>	Overall Length <small>Inch (mm)</small>	Motor  <small>HP</small>	Net Weight <small>LBS kg</small>	Air Hose <small>Inch</small>	Sound Pressure <small>dBA</small>	Vibration Level <small>m/s²</small>
QC-213	3"(75)	20000	10.0(283)	90(6.3)	7-7/8"(200)	0.9	1.9 0.86	3/8"	80.2	10.8
QC-234	4"(100)	16000	10.0(283)	90(6.3)	14"(355)	0.9	3.5 1.59	3/8"	85.0	5.0
QB-49602	6"(152)	10000	3.60(102)	90(6.3)	8-21/32"(220)	0.75	2.0 0.91	3/8"	92.5	3.3 9.5 Orbit

	Strokes Length	Strokes Per min <small>S.P.M</small>	Avg. Air Consumption <small>CFM (L/min)</small>	Air Pressure <small>PSI (bar)</small>	Overall Length <small>Inch (mm)</small>	Net Weight <small>LBS kg</small>	Air Hose <small>Inch</small>	Sound Pressure <small>dBA</small>	Vibration Level <small>m/s²</small>	Cut Capacity <small>mm</small>
QG-202	N/A	2600	6.5(184)	90(6.3)	8-1/4"(210)	2.43 1.1	3/8"	89.1	2.9	1.6
QG-103	N/A	2600	3.0 (85)	90(6.3)	7-3/5"(193)	2.2 1.0	3/8"	88.0	2.8	1.6
QC-321	14.5	11000	4.5(113)	90(6.2)	9-1/4"(230)	1.7 0.6	3/8"	83.0	2.0	N/A

# AIR DRILLS



**QE-334**  
**3/8" Air Drill**  
**With Key Chuck**  
 Air inlet 1/4"



**QE-331**  
**3/8" Air Reversible Drill**  
**With Keyless Chuck**  
 Air inlet 1/4"



**QE-341**  
**1/2" Air Reversible Drill**  
**With Keyless Chuck**  
 Air inlet 1/4"

	Chuck Size	Free Speed	Avg. Air Consumption	Air Pressure	Overall Length	Net Weight		Air Hose	Sound Pressure	Vibration Level
	inch(mm)	R.P.M	CFM (L/min)	PSI (bar)	Inch (mm)	LBS	kg	Inch	dBA	m/s <sup>2</sup>
QE-331	3/8"(10)	1800	6.5(184)	90(6.3)	8"(203)	2.42	1.1	3/8"	96.5	0.3
QE-334	3/8"(10)	2200	6.5(184)	90(6.3)	7-1/2"(190)	2.20	1.0	3/8"	92.0	0.2
QE-341	1/2"(13)	800	6.5(184)	90(6.3)	9"(230)	3.96	1.8	3/8"	96.5	0.1

## QE-431

**3/8" Air Reversible Drill  
With Keyless Chuck**

Air inlet 1/4"



## QE-434

**3/8" Air Drill  
With Key Chuck**

Air inlet 1/4"



## QE-441

**1/2" Air Reversible Drill  
With Keyless Chuck**

Air inlet 1/4"



## QE-443

**1/2" Air Reversible Drill  
With Key Chuck**

Air inlet 1/4"

	Chuck Size inch(mm)	Free Speed R.P.M	Avg. Air Consumption CFM (L/min)	Air Pressure PSI (bar)	Overall Length Inch (mm)	Net Weight LBS kg		Air Hose Inch	Sound Pressure dBA	Vibration Level m/s <sup>2</sup>
QE-431	3/8"(10)	1800	4.0(112)	90(6.3)	8-29/32"(226)	2.6	1.18	3/8"	90.0	3.0
QE-434	3/8"(10)	2200	4.8(135)	90(6.3)	9-1/16"(230)	2.7	1.23	3/8"	90.0	3.0
QE-441	1/2"(13)	1100	4.0(112)	90(6.3)	10-53/64"(270)	3.5	1.58	3/8"	90.0	3.0
QE-443	1/2"(13)	1100	4.0(112)	90(6.3)	10-53/64"(270)	3.8	1.73	3/8"	90.0	3.0

# AIR SCREWDRIVERS

## RA-101

**Air Screwdriver**  
(Twin Dog Type)  
**Screw capacity:M4**  
Air inlet 1/4"



## RA-102

**Air Screwdriver**  
(Twin Dog Type)  
**Screw capacity:M5**  
Air inlet 1/4"



## RA-105

**Air Screwdriver**  
(Twin Dog Type)  
**Screw capacity:M6**  
Air inlet 1/4"



## RA-110

**Air Screwdriver**  
(Twin Hammer Type)  
**Screw capacity:M6**  
Air inlet 1/4"



	Chuck Size	Torque Range	Free Speed	Avg. Air Consumption	Air Pressure	Overall Length	Net Weight	Air Hose	Sound Pressure	Vibration Level
	inch(mm)	FT-LB(Nm)	R.P.M	CFM (L/min)	PSI (bar)	Inch (mm)	LBS kg	Inch	dBA	m/s <sup>2</sup>
RA-101	1/4"(6.35)	3.7-8.9(5-12)	9000	6.0(170)	90(6.3)	6-1/2"(166)	1.32 0.6	3/8"	85.7	2.2
RA-102	1/4"(6.35)	3.7-10.3(5-14)	9000	6.0(170)	90(6.3)	6-3/4"(172)	1.54 0.7	3/8"	86.7	3.7
RA-105	1/4"(6.35)	3.7-16.2(5-22)	8500	8.5(241)	90(6.3)	8-1/4"(208)	2.2 1.0	3/8"	96.7	4.9
RA-110	1/4"(6.35)	3.7-29.5(5-40)	8500	8.5(241)	90(6.3)	8-1/4"(208)	2.2 1.0	3/8"	96.7	4.9





**RA-802**  
**Air Screwdriver**  
 (Adjustable Clutch)  
**Screw capacity:M6**

Air inlet 1/4"



**RA-2272**  
**Air Screwdriver**  
 (Twin Dog Type)  
**Screw capacity:M8**

Air inlet 1/4"

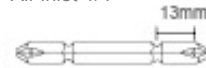

**RA-811**  
**Air Screwdriver**  
 (Positive Clutch Type)  
**Screw capacity:M6**

Air inlet 1/4"



**RA-402**  
**Air Screwdriver**  
 (Positive Clutch Type)  
**Screw capacity:M6**

Air inlet 1/4"

	Chuck Size	Torque Range	Free Speed	Avg. Air Consumption	Air Pressure	Overall Length	Net Weight		Air Hose	Sound Pressure	Vibration Level
	inch(mm)	FT-LB(Nm)	R.P.M	CFM (L/min)	PSI (bar)	Inch (mm)	LBS	kg	Inch	dBA	m/s <sup>2</sup>
RA-402	1/4"(6.35)	5-14(6~19)	2200	3.9(111)	90(6.3)	7-3/32"(180)	2.47	1.1	3/8"	91	2.3
RA-2272	1/4"(6.35)	44~177(59~240)	7700	7.0(240)	90(6.3)	7-11/16"(195)	3.0	1.38	3/8"	93	4.9
RA-802	1/4"(6.35)	3.8-13.3(5-18)	800	8.5(241)	90(6.3)	8-9/32"(210)	2.80	1.30	3/8"	83	4.2
RA-811	1/4"(6.35)	5.0-13.05(6-17)	2100	4.0(113)	90(6.3)	7"(178)	2.50	1.13	3/8"	83	3.7

# AIR NEEDLE SCALERS

## SN-268

(19 Needle Set) 1/8" X 7-1/16"

## SN-288

(12 Needle Set) 1/8" X 4-15/16"

SN-268 for SN-1268



SN-288 for SN-1288

## SN-1268

**Air Needle Scaler**

Air inlet 1/4"



## SN-1288

**Air Needle Scaler**

Air inlet 1/4"

## SN-2124

**Air Pistol Grip Needle Scaler**

Air inlet 1/4"

○ 4000 BPM



## SN-2128

**Air Pistol Grip Needle Scaler**

Air inlet 1/4"

○ 3500 BPM



	Needle Diameter	Numbers of Needle	Stroke Length	Bolw Per Minute	Avg. Air Consumption	Air Pressure	Overall Length	Net Weight		Air Hose	Sound Pressure	Vibration Level
	mm	inch(mm)	mm	bpm	CFM (L/min)	PSI (bar)	Inch (mm)	LBS	kg	Inch	dBA	m/s <sup>2</sup>
SN- 1268	3x180	19	28	4600	15(424)	90(6.3)	18-1/8"(460)	6.16	2.8	3/8"	91.0	13.7
SN- 1288	3x123	12	32	5500	3(84.96)	90(6.3)	11-3/8"(290)	2.86	1.3	3/8"	86.0	7.67
SN- 2124	3x180	23	27	4000	7.4(209)	90(6.3)	13-9/16"(350)	7.9	3.6	3/8"	99.0	14.8
SN- 2128	3x180	28	28	3500	7.4(198)	90(6.3)	13-9/16"(335)	6.2	2.8	3/8"	100	8.1

# AIR HAMMERS

## SC-4 CHISEL SET

- Flat Chisel
- Cutting Chisel
- Tapered Punch
- Ripping Chisel
- Tail Pipe Cutter



- SC-415 - Chisel Set / 175mmL / Round
- SC-425 - Chisel Set / 175mmL / Hex

## SC-07C [SET] 7pcs

### Air Hammer

- 1pc- Air Hammer (Various Selections)
- 5pcs-Chisel Kits
- 1pc- Spring Retainer



Item No.	Shank	Contents
SC-0517C	Round Shank	SC-211+SC-415
SC-0527C	Round Shank	SC-212+SC-415

## SC-2B

### Quick Change Retainer



## SC-211C

### Air Hammer Round Shank

Air inlet 1/4"



## SC-212C

### Air Hammer Round Shank

Air inlet 1/4"

	Shank	Chuck Size	Stroke Length	Bolw Per Minute	Avg. Air Consumption	Air Pressure	Overall Length	Net Weight	Air Hose	Sound Pressure	Vibration Level
		inch(mm)	mm	bpm	CFM (L/min)	PSI (bar)	Inch (mm)	LBS kg	Inch	dBA	m/s <sup>2</sup>
	● ○ □										
SC- 211C	●	0.401(10.2)	67	3200	4.0(113)	90(6.3)	6-7/8"(175)	3.74 1.7	3/8"	98.0	12.3
SC- 212C	●	0.401(10.2)	89	2200	4.0(113)	90(6.3)	8-7/8"(225)	4.40 2.0	3/8"	94.7	13.2

# AIR BLOW GUNS



**JC-405C**  
5" nozzle Air Blow Gun

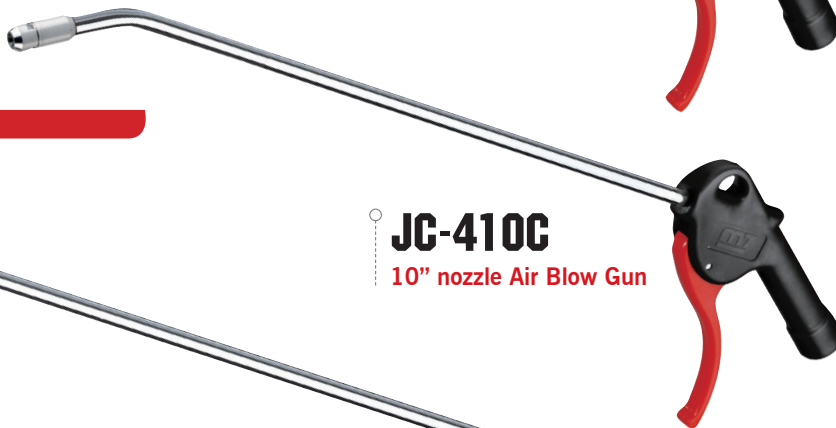

**JC-410C**  
10" nozzle Air Blow Gun

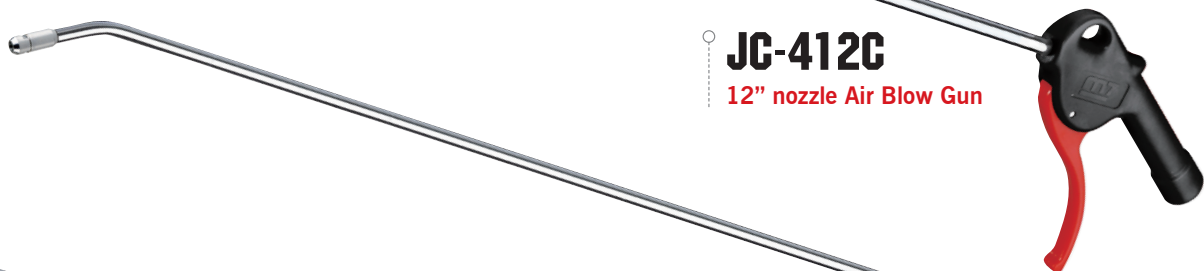

**JC-412C**  
12" nozzle Air Blow Gun

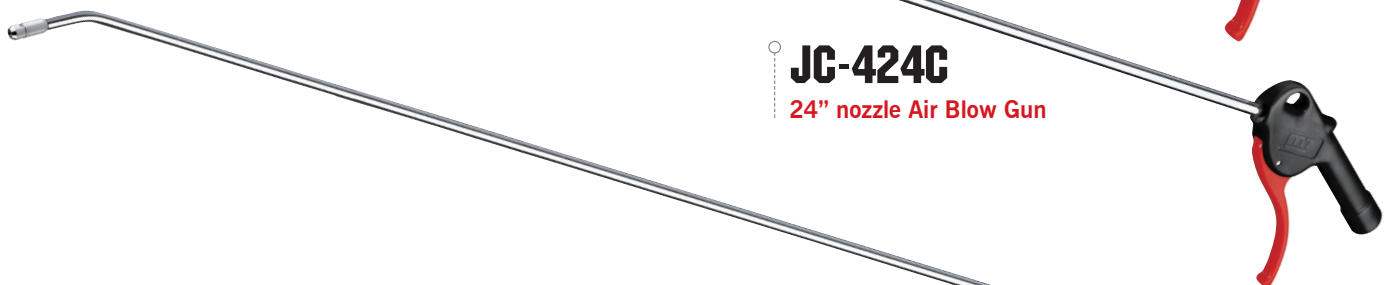

**JC-424C**  
24" nozzle Air Blow Gun

- New innovative designed composite handle
- Up to 50% more durable than other models
- Safety tip included



**JC-435C**  
35" nozzle Air Blow Gun

	Nozzle Length	Working Pressure	Max Pressure	Air Pressure	Net Weight	Air Hose	Sound Pressure
	inch	PSI	PSI	PSI	LBS	inch	dBA
	—	Working	MAX				
JC-405C	5"	75-120	150	90	0.24	3/8"	90.0
JC-410C	10"	75-120	150	90	0.26	3/8"	90.0
JC-412C	12"	75-120	150	90	0.28	3/8"	90.0
JC-424C	24"	75-120	150	90	0.31	3/8"	90.0
JC-435C	35"	75-120	150	90	0.55	3/8"	90.0

# AUTO REPAIR TOOLS

**NEW**



**OP-111**  
1" Air Pistol Sander  
Air inlet 1/4"

**QB-802**  
Air Surface Cleaning Tool  
Air inlet 1/4"



**QB-812T**  
Air Straight Eraser  
Air inlet 1/4"



**QT-113**  
Air Tire Buffer  
Air inlet 1/4"  

- Lock off throttle to prevent accidental start up
- Low RPM design only
- 2500RPM

## QB-9400

Hub is for QB-9411/QB-9412 Wire wheels  
Hub design to fit popular competitive accessories

## QB-9411

4" Wire Wheel (Course)

## QB-9412

4" Wire Wheel (Fine)

## QB-9414

4" Rubber Eraser Wheel

## QB-9415

4" Stripping Wheel



## QB-0808

Air Surface Cleaning Tool Set  
Air inlet 1/4"  

- Hub design to fit popular competitive accessories



	Free Speed R.P.M.	Avg. Air Consumption CFM (L/min)	Air Pressure PSI (bar)	Overall Length Inch (mm)	Motor HP	Net Weight LBS kg	Air Hose Inch	Sound Pressure dBA	Vibration Level m/s <sup>2</sup>
QB-802	3600	10.6(300)	90(6.3)	7-7/8"(200)	0.7	2.6 1.2	3/8"	86	0.3
QT-113	2500	10.6(300)	90(6.3)	9-3/4"(248)	0.5	1.76 .8	3/8"	75	0.87
QB-812T	4000	5.0(141)	90(6.3)	8-15/32"(215)	0.5	1.67 0.76	3/8"	85.0	1.2
OP-111	8000	2.7(152)	90(6.3)	6-3/8"(162.1)	0.3	1.2 0.55	3/8"	89	0.3

# SOCKET SETS AND RAILS



## MA42015M

**15Pc 1/2" Drive Stubby Impact Socket Set METRIC**

- Only 1-1/8" (28mm) tall
- Includes sizes: 10-24mm

Standard Socket



Stubby Socket



Standard impact socket is 1-1/2" compared to 1-1/8" for Stubby impact socket



## MA42011S

**11Pc 1/2" Drive Stubby Impact Socket Set SAE**

- Only 1-1/8" (28mm) tall
- Includes sizes: 5/16", 3/8", 7/16", 1/2", 9/16", 5/8", 11/16", 3/4", 13/16", 7/8", 15/16"

## MA42026

**26Pc 1/2" Drive Stubby Impact Master Socket Set SAE/METRIC**

- Only 1-1/8" (28mm) tall
- Includes sizes: 5/16", 3/8", 7/16", 1/2", 9/16", 5/8", 11/16", 3/4", 13/16", 7/8", 15/16"
- 10-24mm



## MA31026

**26Pc 3/8" Drive Stubby Impact Master Socket Set SAE/METRIC**

- Only 1-3/16" (30mm) tall
- Includes sizes: 5/16", 3/8", 7/16", 1/2", 9/16", 5/8", 11/16", 3/4", 13/16", 7/8"
- 7-22mm

## MA42006M

6pc. 1/2" Drive Stubby  
Impact Socket Set Metric



M7 NO.	Dr.	Size	Length	Weight
	inch	mm	mm	lbs(kg)
MA401M13	1/2"	13	28	0.12(54)
MA401M17	1/2"	17	28	0.15(70)
MA401M19	1/2"	19	28	0.17(80)
MA401M21	1/2"	21	28	0.19(90)
MA401M22	1/2"	22	28	0.22(100)
MA401M24	1/2"	24	28	0.24(110)

## MA42006S

6pc. 1/2" Drive Stubby  
Impact Socket Set SAE



M7 NO.	Dr.	Size	Length	Weight
	inch	inch	mm	lbs(kg)
MA401S16	1/2"	1/2"	28	0.12(54)
MA401S18	1/2"	9/16"	28	0.15(70)
MA401S20	1/2"	5/8"	28	0.17(80)
MA401S22	1/2"	11/16"	28	0.19(90)
MA401S24	1/2"	3/4"	28	0.22(100)
MA401S28	1/2"	7/8"	28	0.24(110)



## MB35012S

12pc. 3/8" Drive Deep  
Impact Socket Set SAE

- 5/16", 3/8", 7/16", 1/2", 9/16", 5/8", 11/16", 3/4", 13/16", 7/8", 15/16", 1"



## MB44008S

8pc. 1/2" Drive Impact  
Hex Driver Set SAE

- 1/4", 5/16", 3/8", 7/16", 1/2", 9/16", 5/8", 3/4"

## MB44008M

8pc. 1/2" Drive Impact  
Hex Driver Set Metric

- 6, 7, 10, 12, 14, 17, 19mm



## AD-2312

3/8" Drive 12"  
Magnetic Aluminum Socket Rail  
w/ 12 clips



## AD-2412

1/2" Drive 12" Magnetic Aluminum  
Socket Rail w/12 clips

- Sockets not included with rail



# MA4130

3pc. 1/2" Drive Impact Deep Thin Wall Flip Socket Set

- 3pcs. 1/2" Drive Flip Socket Set  
3/4" x 13/16"  
17MM x 19MM  
21MM x 22MM



# MB64008SP

8pc. 3/4" drive impact socket set SAE

- 6PT Standard SAE sockets from 3/4" - 1-1/2"

# MA52019



19 Pc. Hex Thru-Hole Socket Set

- 8 Pc. of each SAE and Metric thru-hole sockets
- 1 Pc. 3" thru-hole extension bar
- 2 Pc. Adapters 3/8" & 1/2 Dr.



# MA412S2426 MA412M1719 MA412M2122



1/2" Dr. Impact Deep Thin Wall Flip Socket

M7 NO.		D1	D2	L	
	Hex Size	Inch (mm)	Inch (mm)	Inch (mm)	LBS
MA412S2426	3/4"x13/16"	1-1/32"(26)	1-3/32"(28)	2-31/32"(76)	0.06
MA412M1719	17x19mm	1-1/32"(26)	1-3/32"(28)	2-31/32"(76)	0.07
MA412M2122	21x22mm	1-3/16"(30)	1-1/4"(32)	2-31/32"(76)	0.10



# MA8050

5pc. 1" Drive Combination Budd Wheel Impact Socket Set

M7 NO.		D	D1	ℓ	L	
	mm	mm	mm	mm	mm	LBS(kg)
MA812S4826	1-1/2"	57	57	13/16"	99	2.95(1.34)
MA812M3517	35	52	54	17	94	2.42(1.10)
MA812M3820	38	54	56	20	96	2.6(1.18)
MA812M4121	41	54	58	21	99	2.62(1.19)
MA831M33L	33	52	52	---	90	2.22(1.01)
MA8050	---	---	---	---	---	13.66(6.20)

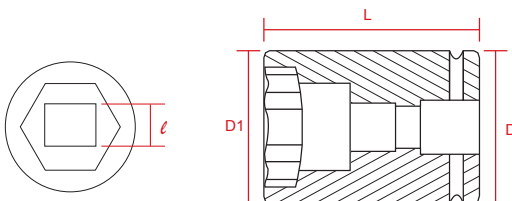



# ACCESSORIES & AFTER MARKET SUPPORT

## ZB-01

### Protective Boot

- Fits on NC-3610Q, NC-3611Q, NC-4610Q and NC-4611Q impact wrenches



## ZB-02

### Protective Boot

- Fits on NC-4236Q, NC-4246Q, NC-6236Q, NC-6246Q



## ZB-06

### Protective Boot

- Fits on NC-4232Q



## ZB-05

### Protective Boot

- Fits on NC-4630Q impact wrenches



## ZB-07

### Protective Boot

- Fits on NC-4255Q/NC-4265Q

## ZB-09

### Protective E

- Fits on NC-6255Q/ NC-6255Q-6



## ZB-08

### Protective Boot

- Fits on NC-4256Q



## ZB-03

### M7 Bag - 16" Heavy Duty Rubber Base Tool bag





**AD-306**

Counter Top Display

- SIZE : 11-13/16"W x 5-1/2"D x 13-3/8" (with three sets adaptor)
- Product not included as shown



**AD-308**

Tower Display

- SIZE: 29"W x 78"H
- Product not included as shown

**AD-3503**

L Type Hook Set For Display Board

- 3PCS: SY-231M + AD 3523 + AD-351

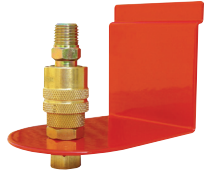

**AD-3603**

L Type Hook Set for Tower Display

- (3PCS=SY-231M+AD 3523+ AD-305-41)



# WARRANTY POLICY

Mighty Seven M7 Brand Tools:

Horizon Tool, Inc. offers a 36 month limited warranty on most products sold in the US and Canada through Horizon Tool Inc. The limited warranty applies to defects in material or workmanship within the applicable limited warranty period. We offer a 12 month limited warranty on 1" and 1½" impact wrenches, air hammers, air chisels, and air blow guns.

These limited warranty programs do not apply to products that have been misused, abused, modified, disassembled or repaired by someone other than an m7 Authorized repair center.

Horizon Tool Inc. reserves the right to conduct an inspection of any tool returned for warranty consideration and will offer the owner of the tool a written evaluation if warranty is denied for any reason. Specific exclusions to this warranty include certain consumable (wear) items in every tool. All consumable items are clearly noted in the parts list for each tool contained in the catalog. Other specific exclusions include failure to properly oil the tool prior to use and using excessive air pressure to operate the tool. All implied warranties, including but not limited to the implied warranties of merchantability or fitness for a particular purpose are also specifically excluded.

In no event shall Horizon Tool Inc. be liable for consequential, incidental or specific damages resulting from or in any manner related to the product, its design, use or any inability to use the same. The sole and exclusive remedy with respect to a defective product shall be the repair, or replacement of the tool.

An RGA number is required for ALL returns to Horizon Tool Inc.. A copy of the proof of purchase must accompany ALL returns to Horizon Tool Inc. and Authorized Service Centers. For any warranty repairs, assistance with a warranty claim, for the name of an authorized m7 warranty repair center nearest you, call Horizon Tool Inc. at 1-800-537-1077 between the hours of 8AM and 5PM, Eastern Time.



# INDEX

## EZ GREASE SERIES AIR IMPACT WRENCHES

NC-4233QHB	3
NC-4255QHB	3
NC-4650HB	3
NC-6255QHB	3

## AIR IMPACT WRENCHES

NC-3612Q	4
NC-4612Q	4
NC-4232Q	5
NC-4620HQ	5
NC-4620QN3	5
NC-4630Q	5
NC-4233Q	6
NC-4236Q	6
NC-4243Q	6
NC-4246Q	6
NC-4255Q	7
NC-4256Q	7
NC-4265Q	7
NC-4256Q-2	7
NC-6255Q	6
NC-6255Q-6	8
NC-6218	9
NC-6236Q	9
NC-6246Q	9
NC-8216	10
NC-8219	10
NC-8226	10
NC-8266P	10
NC-8332-6	11

NC-8351	10
NC-8343-8	11
NC-9223	11
NC-2710	12
NC-0208M	12

## MINI AIR TOOLS

NC-2210N	13
QA-651N	13
QP-212N	14
QP-213N	14
QP-223N	14
QE-323N	15
RA-505N	15

## AIR RATCHET WRENCHES

NE-251	16
NE-321	16
NE-343	16
NE-351	16
NE-352	16
NE-0357	16
NE-421	16
NE-443	16
NE-462	16
NE-362	17
NE-399	17
NE-483	17
NE-499	17
NE-0413M	17
NE-0413S	17

## AIR DIE GRINDERS

QA-111B	18
QA-211B	18
QA-311B	18
QA-313B	18
QA-315B	18
QA-110B	18
QA-116B	18
QA-101B	19
QA-601B	19
QA-611B	19
QA-633QB	19
QA-681B	19

## AIR ANGLE GRINDERS

QB-177	20
QB-179	20
QB-197Q	20
QB-7114SH	20
QB-7145SH	20
QB-7115SH	20

## AIR CUTTING TOOLS

QB-49602	21
QC-213	21
QC-234	21
QD-321	21
QG-103	21
QG-202	21

**AIR DRILLS**

QE-331.....	22
QE-334.....	22
QE-341.....	22
QE-431.....	23
QE-434.....	23
QE-441.....	23
QE-443.....	23

**AIR SCREWDRIVERS**

RA-101.....	24
RA-102.....	24
RA-105.....	24
RA-110.....	24
RA-402.....	25
RA-802.....	25
RA-811.....	25
RA-2272.....	25

**AIR NEEDLE SCALERS**

SN-268.....	26
SN-288.....	26
SN-1268.....	26
SN-1288.....	26
SN-2124.....	26
SN-2128.....	26

**AIR HAMMERS**

SC-211C.....	27
SC-212C.....	27
SC-0517C.....	27
SC-0527C.....	27

SC-2B.....	27
SC-415.....	27
SC-425.....	27

**AIR BLOW GUNS**

JC-405C.....	28
JC-410C.....	28
JC-412C.....	28
JC-424C.....	28
JC-435C.....	28

**AIR AUTO REPAIR TOOLS**

QB-0808.....	29
QB-802.....	29
QB-812T.....	29
QB-9400.....	29
QB-9411.....	29
QB-9412.....	29
QB-9414.....	29
QB-9415.....	29
QP-111.....	29
QT-113.....	29

**SOCKET SETS AND RAILS**

MA31026.....	30
MA42011S.....	30
MA42015M.....	30
MA42026.....	30
AD-2312.....	31
AD-2412.....	31
MB35012S.....	31
MA42006M.....	31

MA42006S.....	31
MB44008M.....	31
MB44008S.....	31
MA4130.....	32
MA412M1719.....	32
MA412M2122.....	32
MA412S2426.....	32
MA8050.....	32
MA52019.....	32
MB64008SP.....	32

**ACCESSORIES**

ZB-01.....	33
ZB-02.....	33
ZB-03.....	33
ZB-05.....	33
ZB-06.....	33
ZB-07.....	33
ZB-08.....	33
ZB-09.....	33

**AFTER MARKET SUPPORT**

AD-306.....	34
AD-308.....	34
AD-3503.....	34
AD-3603.....	34



## Horizon Tool, Inc.

---

Horizon Tool distributes, manufactures and sells specialty tools in the automotive, industrial and hand tool markets

---

Phone: 800-537-1077

Web: [cal-vantools.com](http://cal-vantools.com)

Email: [info@calvantools.net](mailto:info@calvantools.net)

Fax: 800-537-1717

YouTube: [youtube.com/user/calvantools](https://youtube.com/user/calvantools)

Facebook: [facebook.com/calvantools](https://facebook.com/calvantools)

Twitter: [twitter.com/calvantools](https://twitter.com/calvantools)

Web: [m7-us.com](http://m7-us.com)